

### Features

- **Supports all variants of DSVGA OLED**
  - BIT1011B1: EMA-101125 - Color XL
  - EMA-101126 - Monochrome White XL
  - BIT1011B2: EMA-101110-01 - Monochrome Green XLT
- **Low Power: < 1W (less OLED)**
- **Monocular: 1 OLED Channel**
- **Video Interfaces**
  - Analog: SDV: Y, CVBS, YC (S-Video)
  - Digital: 8-bit: Y, BT.656 (YCbCr 4:2:2)
- **Video Timing Formats**
  - Monochrome: (Analog / Digital) NTSC, PAL, VGA, SVGA
  - Color: (Analog) NTSC, PAL
- **User-selectable Control Options**
  - UART, I<sup>2</sup>C, Discrete
- **Continuous Image Optimization**
- **Power Enable / Disable Feature**
  - Rapid start-up
  - Ultra-Low-power disable
- **Ultra-Compact / Low-Profile Design**
- **User-configurable Mounting Features (Tabs)**
- **Industrial Temperature Range (-40~70C)**

**BIT1011B1**  
w/ color  
OLED

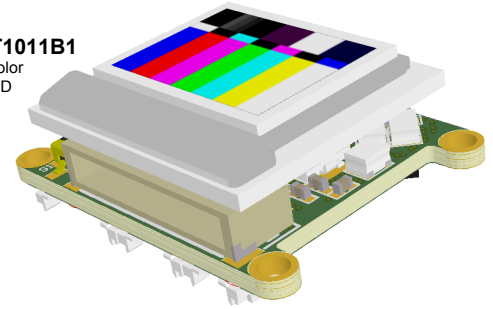

OLEDs shown for illustration purpose, not included

**BIT1011B2**  
w/mono-green  
OLED

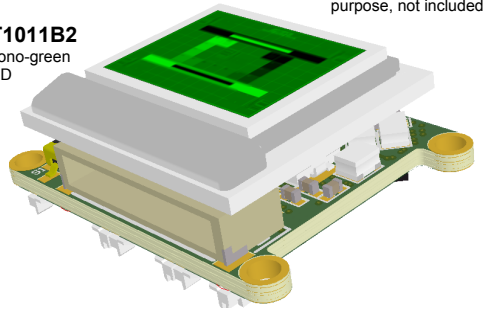

### Applications

- **Head Mounted Displays (HMD)**
- **Wearable Devices**
- **Virtual / Augmented Reality (VR, AR)**
- **Embedded Viewers**
- **Electronic Viewfinder (EVF)**
- **Instrumentation**
- **Hobby**

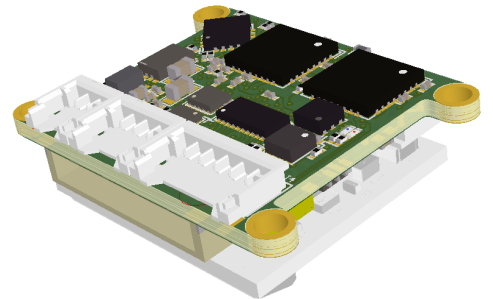

### General Description

The BIT1011B is a high-performance low-cost full-featured driver supporting all variants of the eMagin DSVGA OLED. Integrated dual-mode analog / digital video input and multiple control interface options enable a compact single-board design suitable for virtually any application including binocular HMDs for users with narrow interpupillary distance (IPD).

### Product Highlights

Lightweight low-profile compact design is optimized for both monocular and binocular display devices for both direct-view and reflective eyepiece designs. Compact layout supports easy monocular left/right eye switching as well as binocular side-by side mounting. Image position and orientation controls facilitate rotation and binocular convergence adjustments / fine-tuning.

With all connectors located on a common board edge supports plenum style end-product wire harnessing. This is especially helpful for routing wires along the upper edge of a binocular display assembly to minimize look-down obscuration.

Four configurable #0 mounting tabs provide a flexible easily customizable attachment system suitable for a variety of mechanical configurations. Unused mounting tabs can be easily removed.

The user selectable control interface supports easy adaptation to the most popular serial and discrete control interfaces. The 3.3V UART control option features a unique chip-select allowing multiple OLED drivers to be controlled by a common Tx/Rx pair, a unique feature intended specifically for binocular configurations.

Low operational power plus reduced-power standby and ultra-low-power disable modes provide flexible power control necessary to ensure long battery life for today's and future portable devices.

Additional features such as programmable brightness control steps, maximum brightness, built-in test patterns, user selectable gamma, and video format query give the user all the necessary degrees of control to customize and diagnose the end-product – these user control features are unique to Bild's OLED Drivers.

## Technical Specifications

Parameter				min	typ	max	unit
Input Voltage				2.4	5.0	5.5	V
Power Consumption (less OLED)	Operating	Analog	Y, CVBS	-	425	600	mW
			Y/C	-	475		mW
	Reduced-Power Standby (input video active)	Digital	SDV	-	175		mW
			VESA	-	200		mW
			Power Disabled	-	1	-	mW
Temperature	Operating		-40	-	70	°C	
	Storage		-40	-	85	°C	
Video	Input Type 1: J2 - Analog SDV (Y, CVBS, YC)			1.0			Vpp / 75Ω
	Input Type 2: J3 - Digital (LVCMOS) BT.656, VESA			1.0	1.8~3.3	4.5	V
	Color Depth	Color	Analog: CVBS, Y/C Digital: BT.656	YCbCr 4:2:2			
		Monochrome	Analog: Y Digital: VESA	8 bit			
	Frame Resolution	Analog	SDV: NTSC, RS-170(A)	640 x 480			HxV
			SDV: PAL	768 x 576			HxV
		Digital	BT.656: NTSC, RS-170(A)	640 x 480			HxV
			BT.656: PAL	768 x 576			HxV
			VESA: VGA	640x480			HxV
	Frame Rate	SDV	VESA: SVGA	800x600			HxV
NTSC, RS-170A			59.94 / 60			Hz	
VESA		PAL	50			Hz	
				56	-	85	Hz
Control Interface	PWR_EN	Enable	1.4	-	-	V	
		Disable	-	-	0.4	V	
	Serial / Discrete (CTL1 ~ 3)	Logic High	1.82	-	-	V	
		Logic Low	-	-	0.99	V	
	Format	Option 1: UART	3.3V, 115.2kbps				
		Option 2: I <sup>2</sup> C	3.3V, 100 / 400 kbps				
Option 3: Discrete		2-wire, integrated pullups					
Mass				3			g

## Absolute Maximum Ratings

Stresses above those listed under Absolute Maximum Ratings may cause permanent damage to the device. This is a stress rating only; the functional operation of the device at these or any other conditions above those indicated in the operational sections of this specification is not implied. Exposure to absolute maximum rating conditions for extended periods may affect device reliability.

Parameter				min	max	unit
Supply Voltage	J1	Supply Power		-0.3	6.0	V
Power Control	J4	PWR_EN		-0.3	6.0	V
Video Input	J2	Analog		-0.3	2.1	V
	J3	Digital		-0.5	5.5	V
Control IO	J4	CTL1 ~ 3		-0.6	3.9	V
Temperature (ambient)				-40	85	C

## ESD Caution

ESD (electrostatic discharge) sensitive device. Electrostatic charges as high as 4000 V readily accumulate on the human body and test equipment and can discharge without detection. Although this product features ESD protection circuitry, permanent damage may occur on devices subjected to high energy electrostatic discharges. Therefore, proper ESD precautions are recommended to avoid performance degradation or loss of functionality



## Package Outline

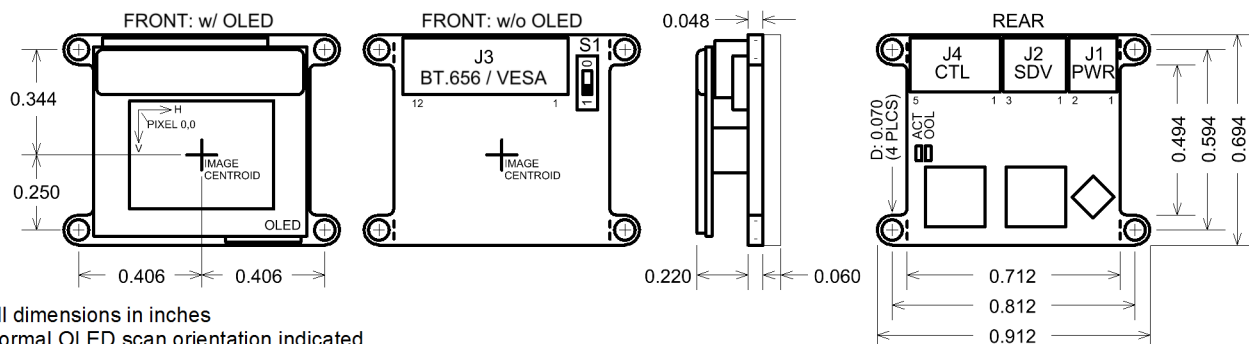

### Notes:

- All dimensions in inches
- Normal OLED scan orientation indicated
- 3D model (STEP) available upon request (with and without OLED)

## Connectors

### J1: Power

Manufacturer: Molex  
 Manufacturer PN: 78171-0002  
 Mating PN: 78172-0002  
 Pinout:

Pin #	Function
1	Supply Power
2	GND

### J2: SDV Input

Manufacturer: Molex  
 Manufacturer PN: 78171-0003  
 Mating PN: 78172-0003  
 Pinout:

Pin #	Function
1	Y / CVBS
2	C
3	GND

### J3: BT.656 Input

Manufacturer: JST  
 Manufacturer PN: SM12B-SRSS-TB(LF)(SN)  
 Mating PN: SHR-12V-S , SHR-12V-S-B  
 Pinout:

Pin #	Function
1	D7
2	D6
3	D5
4	D4
5	D3
6	D2
7	D1
8	D0
9	HS
10	VS
11	CLK
12	GND

### J4: Control

Manufacturer: Molex  
 Manufacturer PN: 78171-0005  
 Mating PN: 78172-0005  
 Pinout:

Pin #	Generic Name	Function (by Control Mode)			Pull-up/down
		Discrete	UART	I2C	
1	CTL0	PD1	TX	SDA	4.3kOhm pullup to 3.3V
2	CTL1	PD2	RX	SCL	4.3kOhm pullup to 3.3V
3	CTL2	MODE_CTL			10kOhm pullup to 3.3V
4	PWR_EN				10kOhm pullup to supply voltage
5	GND				n/a

## Operation

### Supply Power

Setting serial command **POWER** to **0** places the BIT1011B in a reduced power state in which all video functions are disabled but serial communications remain active. Restoring serial command **POWER** to **1** returns the BIT1011B to a fully operational state.

Deasserting J4 pin 4 (PWR\_EN) to logic low places the BIT1011B into an extremely low power state in which serial communication is disabled. Reasserting PWR\_EN to logic high will cause a re-start of the BIT1011B.

### Status Indicator LEDs

The BIT1011B features two (2) status indicator LEDs as follows:

Label	Color	Status Function
<b>ACT</b>	<b>Blue</b>	Luminance modulation indicates processor activity
<b>OOL</b>	<b>Red</b>	ON Valid Video Not Detected
		OFF Valid Video Detected

Status LED locations shown below:

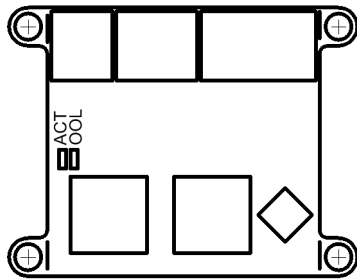

ACT and OOL Status LEDs can be disabled via the **LEDEN** serial command (ref: BIT-UG-0003).

### Input Video Connector Pin Functions:

Connector Pin #	Input Video Standard SDV			Digital BT.656	VESA Digital Y	
	Y	Analog CVBS	YC			
J2	1	Y	CVBS	Y	-	
	2	-	-	C	-	
J3	1	-	-	-	D7	
	2	-	-	-	D6	
	3	-	-	-	D5	
	4	-	-	-	D4	
	5	-	-	-	D3	
	6	-	-	-	D2	
	7	-	-	-	D1	
	8	-	-	-	D0	
	9	-	-	-	NC	HS
	10	-	-	-	NC	VS
	11	NC	NC	NC	CLK	CLK

"-" = don't care

"nc" = No Connect

## Input Video Source Selection

The BIT1011B supports a variety of user-configurable video source control options according to the following table.

Command Value (ref: BIT-UG-0003)				Input Control			No Video Display	Notes	
VSRC	SDVA	SDVD	VTD	Mode	Analog	Applied Formats Digital			
0	0	0	-	Auto	Y, CVBS	NTSC : YCrCb	BT.656 w/sync VESA	Blue Screen	Digital input, when present, receives priority over analog input. SDVD applied if no sync detected.
		1				PAL : YCrCb			
	1	0			Y/C	NTSC : YCrCb			
		1			PAL : YCrCb				
1	0	-	Analog	Y, CVBS	-	Blue Screen			
	1	-		Y/C					
2	-	0	-	Digital less sync	-	NTSC : YCrCb	Black Screen		
		1				PAL : YCrCb			
3	-	-	-	-	-	-	-	Reserved	
4	-	-	0	Digital w/sync	-	reserved	Black Screen		
			1			reserved			
			2			VESA 640x480_60			
			3			VESA 640x480_72			
			4			VESA 640x480_75			
			5			VESA 640x480_85			
			6			VESA 800x600_56			
			7			VESA 800x600_60			
			8			VESA 800x600_72			
			9			VESA 800x600_75			
			10			VESA 800x600_85			

"-" = don't care



## Input Video Formats: Digital VESA

The BIT1011B digital video interface supports the following VESA timing formats:

Timing Parameter	640 x 480				800 x 600				unit	
	60 Hz	72 Hz	75 Hz	85 Hz	56 Hz	60 Hz	72 Hz	75 Hz		85 Hz
FP Pixel Clock Frequency	25.175	31.500	31.500	36.000	36.000	40.000	50.000	49.500	56.250	MHz
FH Horizontal Frequency	31.469	37.861	37.500	43.269	35.156	37.879	48.077	46.875	53.674	kHz
FV Vertical Frequency	59.940	72.809	75.000	85.008	56.250	60.317	72.188	75.000	85.061	Hz
HS Horizontal Sync	96	40	64	56	7	128	120	80	64	col
HB Horizontal Backporch	48	128	120	80	128	88	64	160	152	col
HA Horizontal Active	640	640	640	640	800	800	800	800	800	col
HF Horizontal Frontporch	16	24	16	56	24	40	56	16	32	col
HT Horizontal Total	800	832	840	832	1024	1056	1040	1056	1048	col
VS Vertical Sync	2	3	3	3	2	4	6	3	3	row
VB Vertical Backporch	33	28	16	25	22	23	23	21	27	row
VA Vertical Active	480	480	480	480	600	600	600	600	600	row
VF Vertical Frontporch	10	9	1	1	1	1	37	1	1	row
VT Vertical Total	525	520	500	509	625	628	666	625	631	row

## Image Orientation

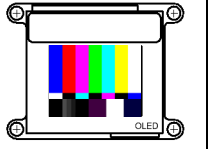
Image orientation is adjustable via discrete and serial control according to the following table.

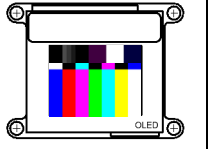
HSCAN	VSCAN	Image Orientation	HSCAN	VSCAN	Image Orientation
0	0		1	0	
0	1		1	1	

## Control Interface – Channel Selection

The BIT1011B is controlled via one of several user-selectable interfaces according to the following table:

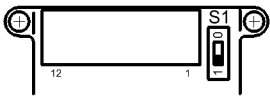
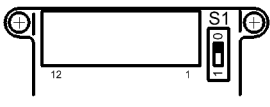
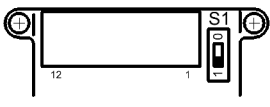
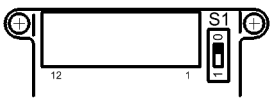
S1 Switch Position Physical	Logical	J4 IOs			Selected Function
		CTL2	CTL1	CTL0	
	0	0	0 0 1 1	0 1 0 1	<b>Discrete:</b> Image Flip – H/V SCAN <b>Discrete:</b> BRT Decrement <b>Discrete:</b> BRT Increment <b>Discrete:</b> No Operation
	1	0	Rx	Tx	<b>UART</b> <i>CTL2 may be used as a UART enable:            0 = enabled, 1 = disabled</i>
	0	1	SCL	SDA	I <sup>2</sup> C: slave address 0x74
	1	1	SCL	SDA	I <sup>2</sup> C: slave address 0x75

## Control Interface - Serial

UART and I<sup>2</sup>C serial control interface, protocol, and commands are described by the following documents:

- BIT-UG-0000** User Guide, UART Protocol, General
- BIT-UG-0003** User Guide, UART Protocol, OLED Driver
- BIT-UG-0004** User Guide, I<sup>2</sup>C Protocol, OLED Driver

## Control Interface - Discrete

Discrete control is implemented via a 2-wire logic interface whereby control action is initiated by driving one or both inputs to GND (logic low). These inputs can be driven by active digital logic or simple pull-down as by a normally-open switch. The control action is defined by the table below. All control actions are executed upon release (return to logic high) – no sustained assertion actions are supported. The Image Orientation Flip control action performs sequential alternating horizontal and vertical scan reversals (flips) upon successive assertions as follows:

PD1	PD2	Control Action
1	1	No operation
0	1	Brightness Increment
1	0	Brightness Decrement
0	0	Image Orientation Flip

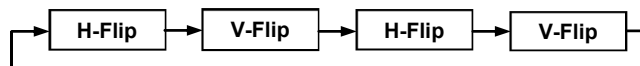

## Brightness Control

BIT1011B brightness is adjusted in perceptually linearized discrete steps defined by control parameters **BRT**, **BRTMOD**, and **MAXLUM** (ref: BIT-UG-0003) as illustrated below (normalized luminance scale).

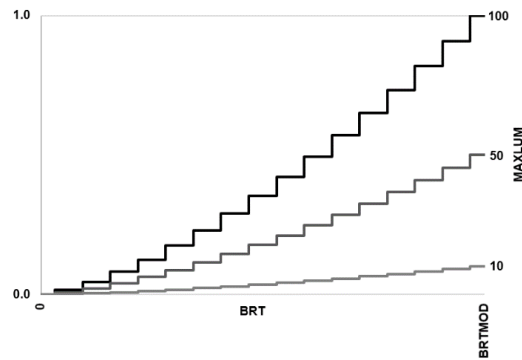

Serial control supports direct arbitrary control of the **BRT**, **BRTMOD**, and **MAXLUM** brightness control parameters. Discrete control supports single-step increment and decrement of the **BRT** parameter.

## Gamma Control

BIT1011B gamma is adjusted by the **GAMMA** command (ref: BIT-UG-0001) which applies a standard normalized exponential transfer function ( $\text{PixelValue}^{\text{GAMMA}}$ ) to emulate CRT phosphor characteristics as shown below.

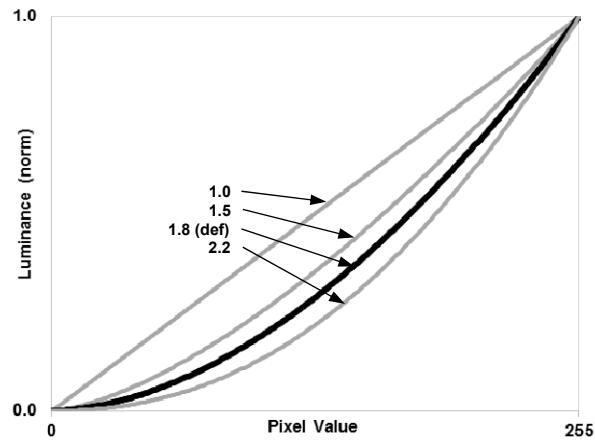

## Mounting Tabs

The BIT1011B features four (4) configurable EMI mounting tabs featuring .070" diameter through-plated holes located at the corners and provide direct coupling to GND. To accommodate a variety of mechanical mounting configurations, these tabs can be removed as needed from the OLED Driver by breaking away at the pre-cut v-groove break lines. Care must be taken to prevent damage to the OLED Driver.

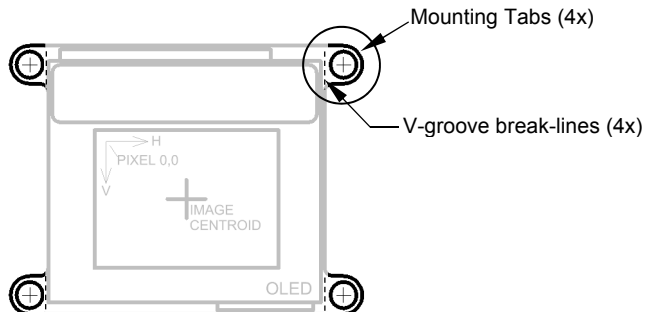

## OLED Installation

To prevent misalignment, it is recommended to remove the OLED's serial number label which may interfere with J3.

OLED serial number may be queried using the **OLED SN** command.

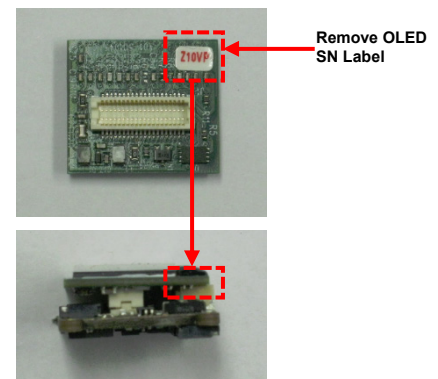

## Orderable Part Numbers

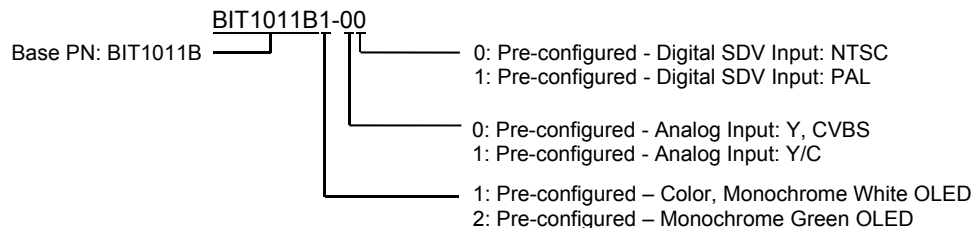

## Contact

Bild Innovative Technology LLC  
2656 W Montrose Ave Suite 203  
Chicago, IL 60618  
(773) 697-9345  
(760) 450-6633  
pbeerdeke@bildinnotech.com



**Revision History**

<b>Rev</b>	<b>Date</b>	<b>Description</b>
<b>A</b>	<b>02/01/19</b>	Initial Release
<b>B</b>	<b>02/05/19</b>	Updated Technical Specifications, Input Video Source Selection
<b>C</b>	<b>02/28/19</b>	Updated Package Outline
<b>D</b>	<b>03/22/19</b>	Corrected Operation, Supply Power description Removed BT.656+HV input support Corrected Input Video Connector Pin Functions table
<b>E</b>	<b>06/12/19</b>	Added <b>GAMMA</b> description
<b>F</b>	<b>08/15/19</b>	Added I2C support
<b>F1</b>	<b>10/01/19</b>	Corrected Monochrome Green OLED Part Number